

RAKSA



TYP

nierozkładany

WYPEŁNIENIE

pasy elastyczne

system SoftLayers™ – kompozycja specjalnie dobranych pianek elastycznych dla uzyskania najlepszego komfortu
selekcjonowane pierze naturalne o wysokiej klasie sprężystości/ możliwość zamiany na wypełnienie antyalergiczne

PODUSZKI OPARCIOWE

selekcjonowane pierze naturalne o wysokiej klasie sprężystości/ możliwość zamiany na wypełnienie antyalergiczne

RAMA

metal, kolor czarny mat

PÓŁKA

fornir dębowy



fornir dębowy czarny



orzech amerykański



Wymiary techniczne Sofa RAKSA (mm)					
1	Wysokość całkowita z poduszką	930	6	Szerokość podłokietnika	200
2	Wysokość siedziska	390	7	Głębokość całkowita	1000/1200
3	Wysokość oparcia	685	8	Głębokość siedziska	800/1000
4	Wysokość podłokietnika	595	9	Głębokość siedziska z poduszką	720/920
5	Powierzchnia spania	-	10	Wysokość nóżek	25

Siedzisko centralne A1

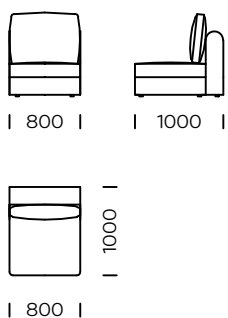

Siedzisko centralne A2

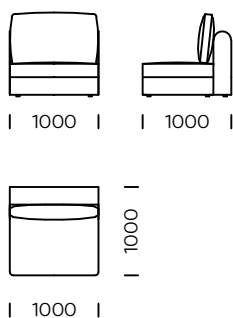

Siedzisko centralne A3

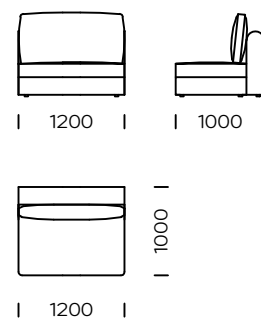

Siedzisko centralne B1

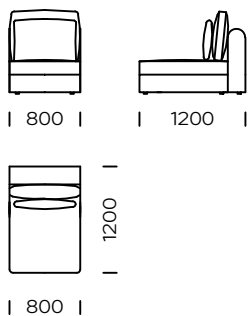

Siedzisko centralne B2

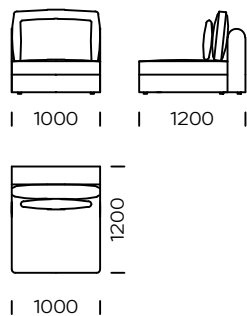

Siedzisko centralne B3

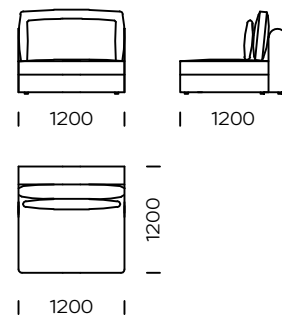

Pufa 1

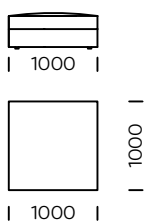

Pufa 2

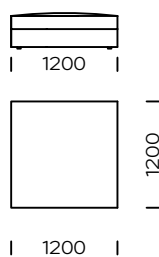

Poduszka

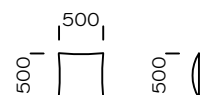

Wszystkie oferowane elementy można zamówić w formie odbicia lustrzanego

Siedzisko centralne C1

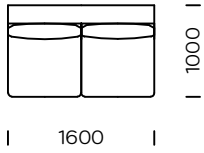
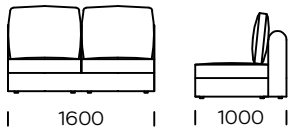

Siedzisko centralne C2

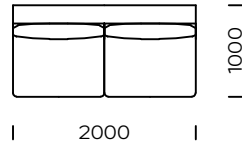
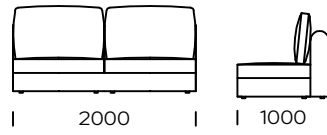

Siedzisko centralne C3

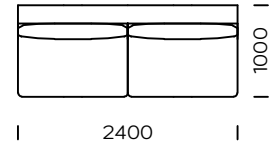
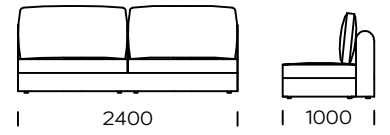

Siedzisko centralne D1

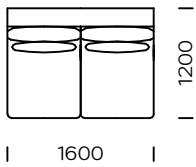
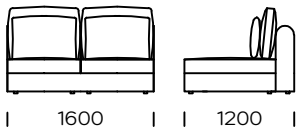

Siedzisko centralne D2

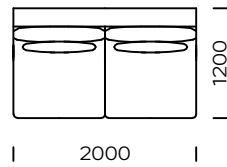
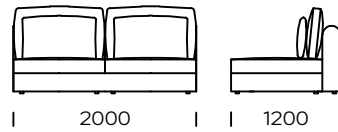

Siedzisko centralne D3

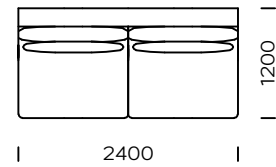
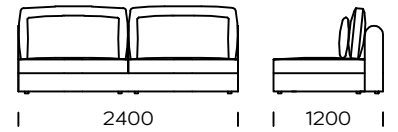

Siedzisko lewe A1

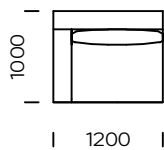
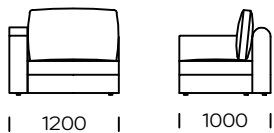

Siedzisko lewe A2

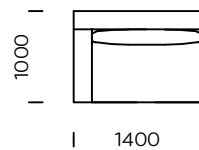
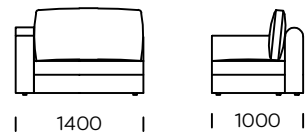

Wszystkie oferowane elementy można zamówić w formie odbicia lustrzanego

Siedzisko lewe B1

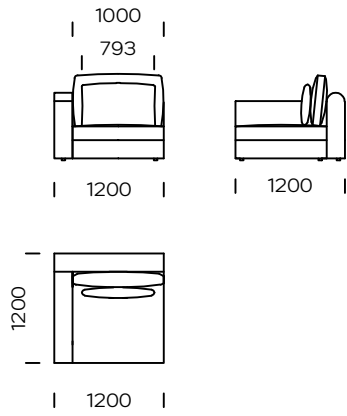

Siedzisko lewe B2

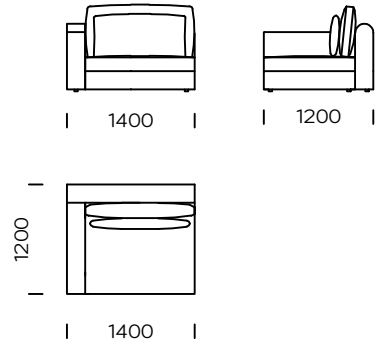

Siedzisko narożne A

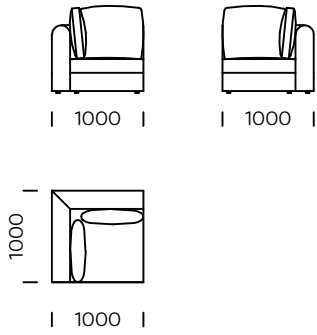

Siedzisko narożne B

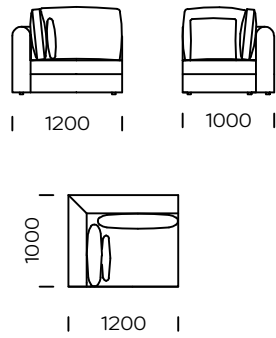

Siedzisko narożne C

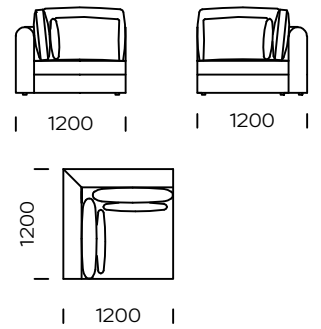

Szezelong lewy 1

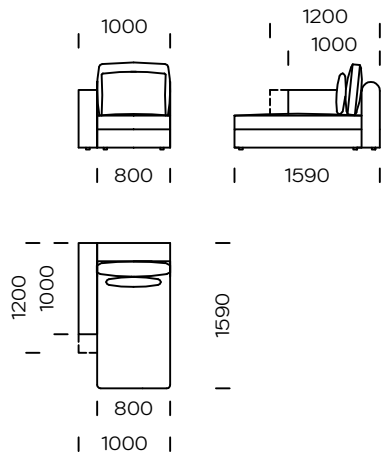

Szezelong występuje z podłokietnikiem A lub B

Szezelong lewy 2

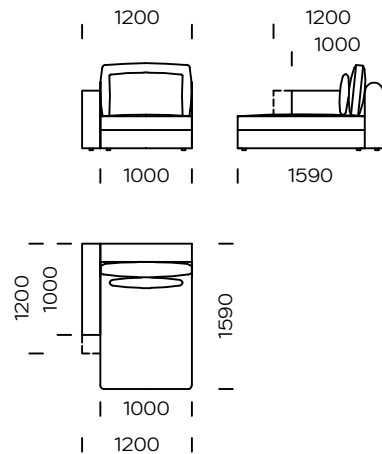

Szezelong występuje z podłokietnikiem A lub B

Wszystkie oferowane elementy można zamówić w formie odbicia lustrzanego

Tapczan lewy A1

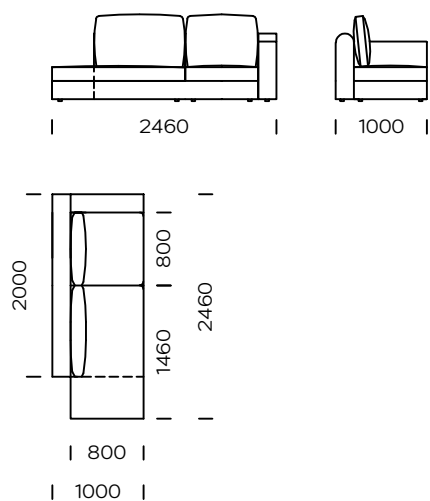

Tapczan lewy A2

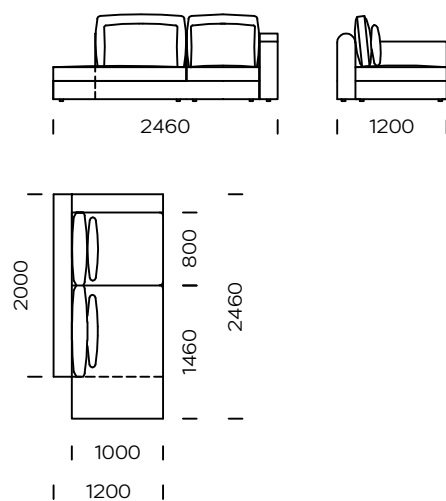

Tapczan lewy B1

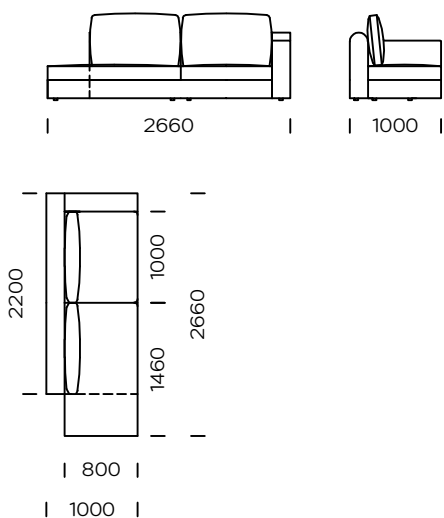

Tapczan lewy B2

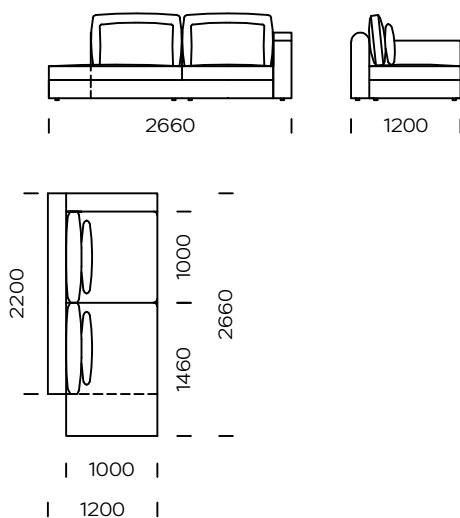

Stolik 1

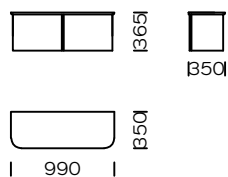

Stolik 2

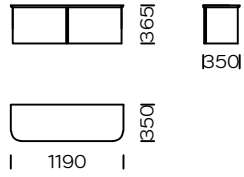

Podłokietnik zewnętrzny 1



Podłokietnik zewnętrzny 2



Wszystkie oferowane elementy można zamówić w formie odbicia lustrzanego