

# RAKSA



## TYP

nicht aufgeklappt

## FÜLLUNG

elastische Bänder, SoftLayers™-System - eine Komposition aus speziell ausgewählten elastischen Schäumen für besten Komfort, ausgewählte Naturfedern hoher Elastizitätsklasse / kann durch antiallergische Füllung ersetzt werden

## RÜCKENLEHNENKISSEN

ausgewählte Naturfedern hoher Elastizitätsklasse / kann durch antiallergische Füllung ersetzt werden

## RAHMEN

Metall, schwarz matt

## ABLAGE

Eichenfurnier



schwarzes Eichenfurnier



amerikanischer Nussbaum



Technische Abmessungen Sofa RAKSA (mm)					
1	Gesamthöhe mit Kissen	930	6	Armlehnenbreite	200
2	Sitzhöhe	390	7	Gesamttiefe	1000/1200
3	Rückenlehnenhöhe	685	8	Sitztiefe	800/1000
4	Armlehnenhöhe	595	9	Sitztiefe mit Kissen	720/920
5	Schlaffläche	-	10	Höhe der Beine	25

**Mittelsitz A1**

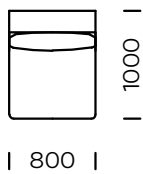
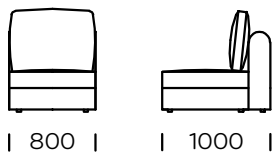

**Mittelsitz A2**

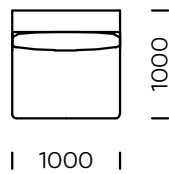
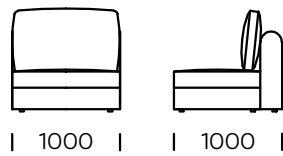

**Mittelsitz A3**

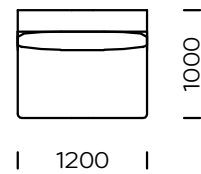
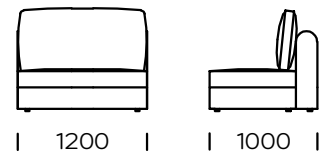

**Mittelsitz B1**

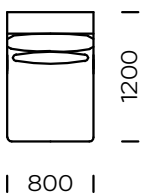
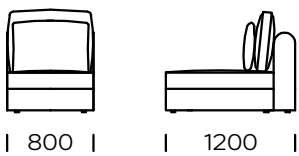

**Mittelsitz B2**

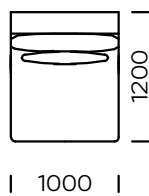
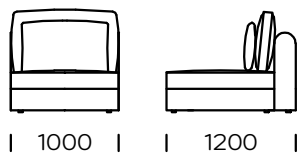

**Mittelsitz B3**

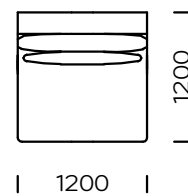
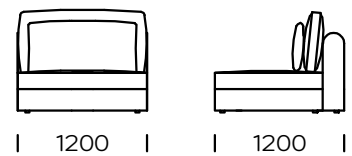

Alle angebotenen Elemente können spiegelbildlich bestellt werden

**Mittelsitz C1**

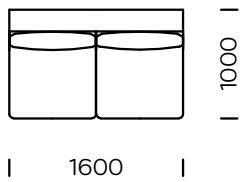
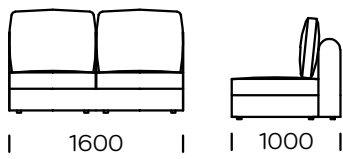

**Mittelsitz C2**

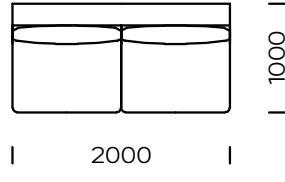
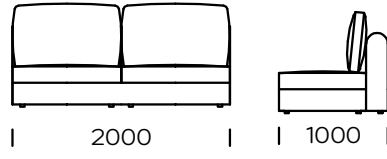

**Mittelsitz C3**

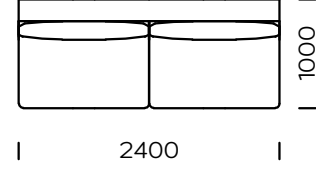
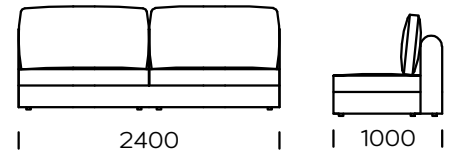

**Mittelsitz D1**

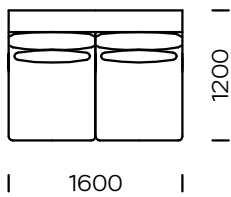
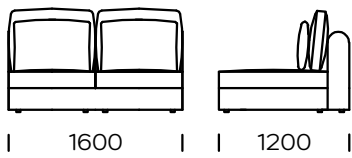

**Mittelsitz D2**

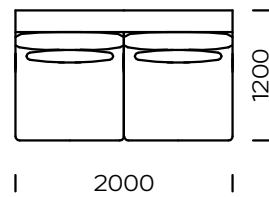
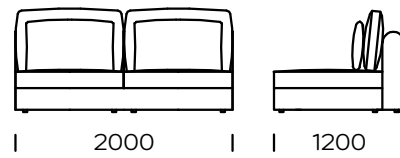

**Mittelsitz D3**

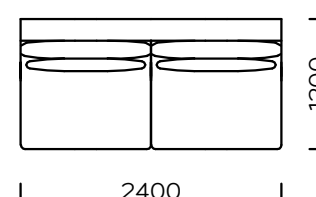

**Äußere Armlehne 1**

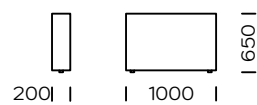

**Äußere Armlehne 2**

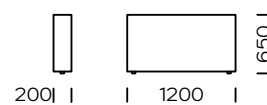

**Kleiner Tisch 1**

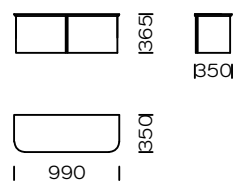

**Kleiner Tisch 2**

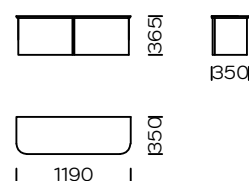

Alle angebotenen Elemente können spiegelbildlich bestellt werden

**Ecksitz A**

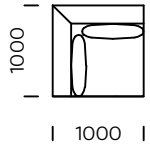
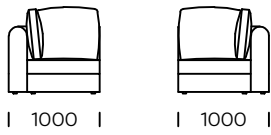

**Ecksitz B**

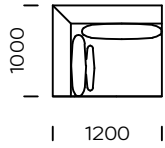
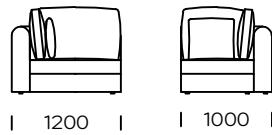

**Ecksitz C**

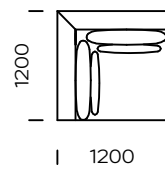
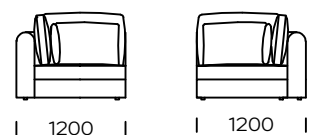

**Links Sitz A1**

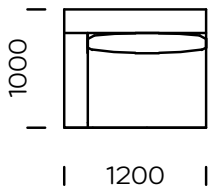
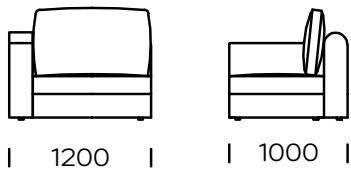

**Links Sitz A2**

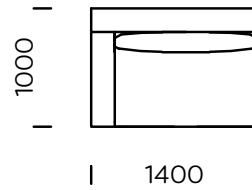
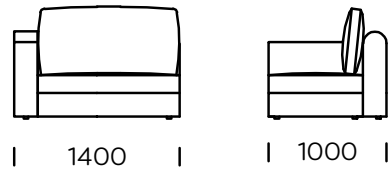

**Links Sitz B1**

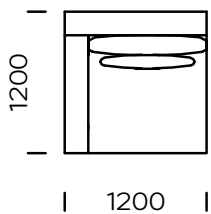
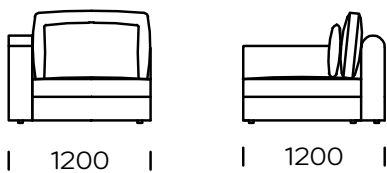

**Links Sitz B2**

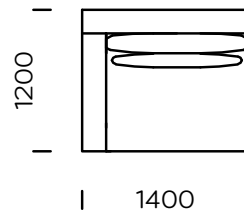
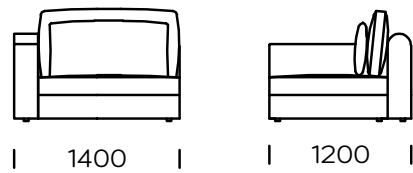

Alle angebotenen Elemente können spiegelbildlich bestellt werden

### Linke Chaiselongue 1

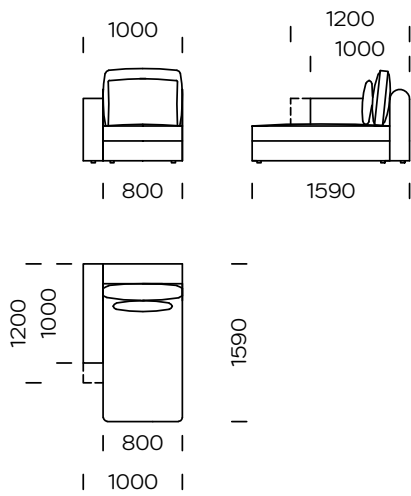

### Linke Chaiselongue 2

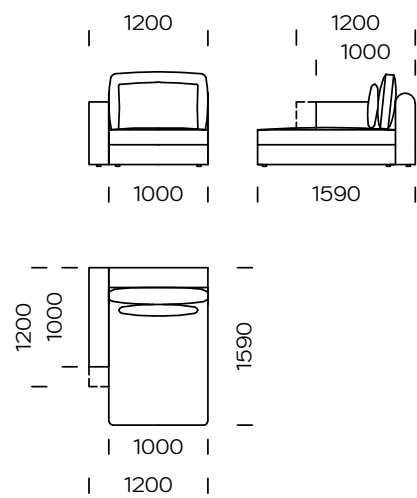

Chaiselongue 1/2 ist mit Armlehne A oder B erhältlich

### Schlafsofa A1, links

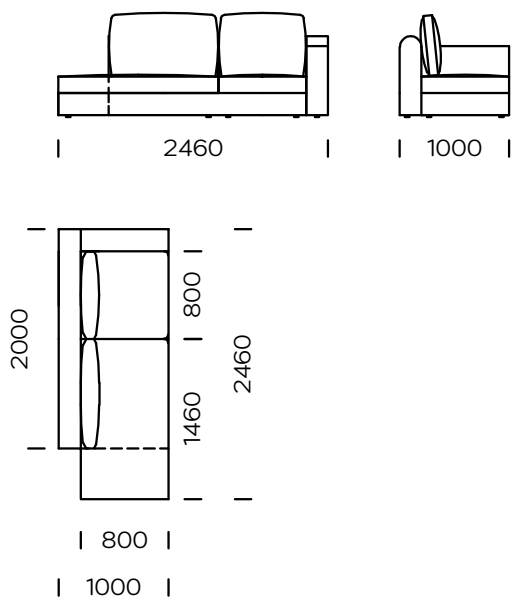

### Schlafsofa A2, links

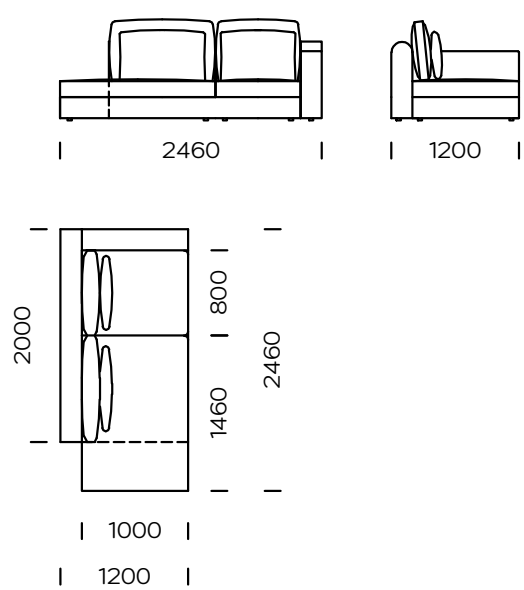

Alle angebotenen Elemente können spiegelbildlich bestellt werden

**Schlafsofa B1, links**

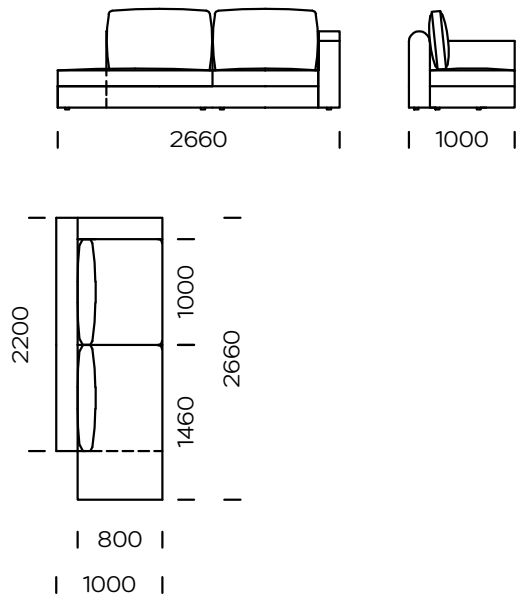

**Schlafsofa B2, links**

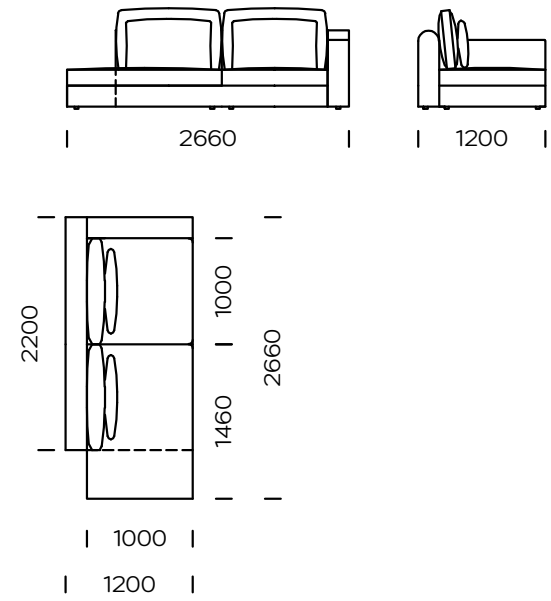

**Puff 1**

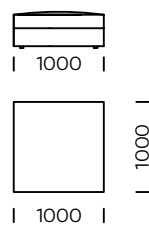

**Puff 2**

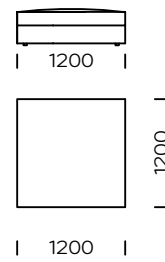

**Kissen**

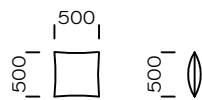

Alle angebotenen Elemente können spiegelbildlich bestellt werden