

# RAKSA



## TYPE

non-folding

## FILLING

flexible stripes

SoftLayers™ system – a composition of specially selected flexible foams to ensure the best comfort  
selected natural feathers of high elasticity class/  
possible replacement with anti-allergic filling

## BACKREST PILLOWS

selected natural feathers of high elasticity class/  
possible replacement with anti-allergic filling

## FRAME

metal, mat black color

## SHELF

oak veneer



black oak veneer



american walnut



Technical informations (mm)					
1	Total height with cushions	950	5	Armrest width	200
2	Backrest height	740	6	Total depth	1000/1200
3	Seat height	400	7	Seat depth	800/1000
4	Armrest height	650	8	Seat depth with cushions	720/920
			9	Legs height	30

Central seat A1

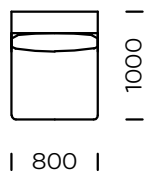
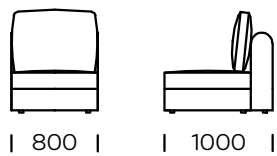

Central seat A2

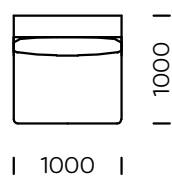
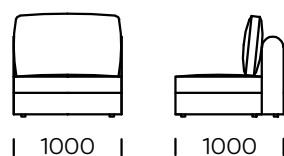

Central seat A3

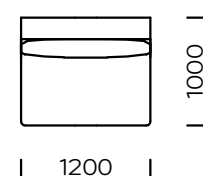
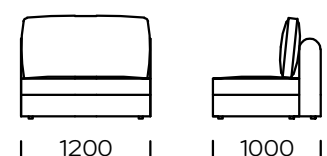

Central seat B1

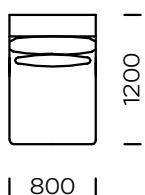
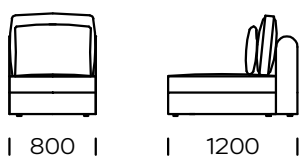

Central seat B2

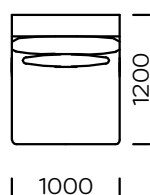
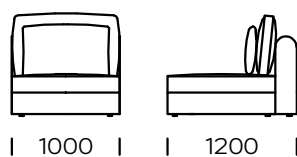

Central seat B3

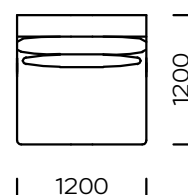
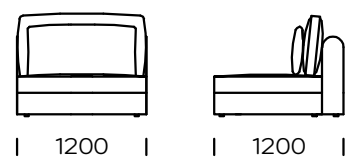

All offered elements can be order in the left and right option

Central seat C1

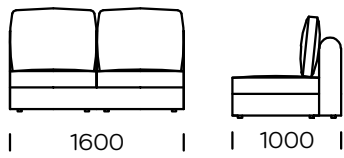

Central seat C2

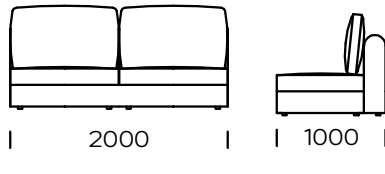

Central seat C3

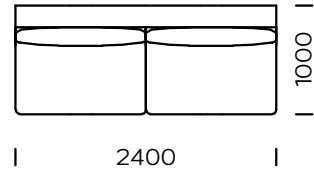
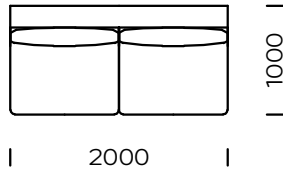
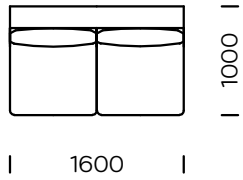
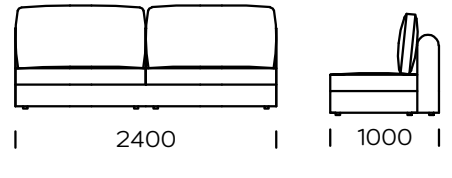

Central seat D1

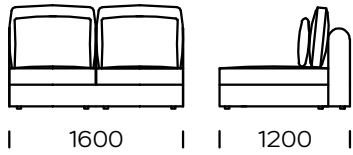

Central seat D2

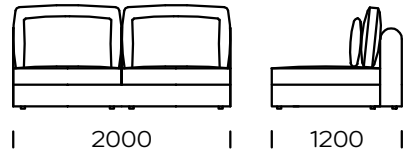

Central seat D3

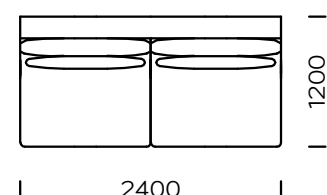
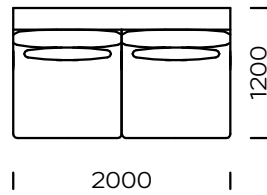
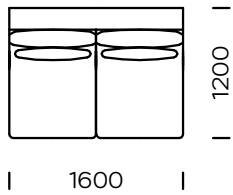

External armrest 1



External armrest 2



Table 1

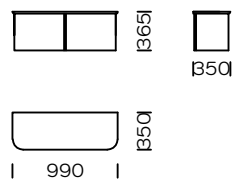
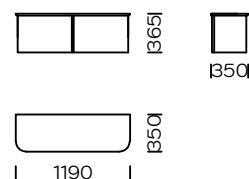
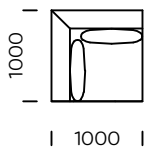
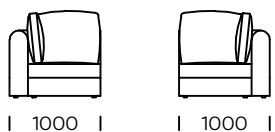

Table 2



All offered elements can be order in the left and right option

Corner seat A



Corner seat B

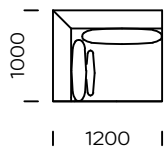
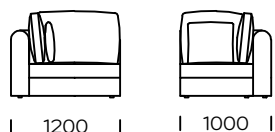

Corner seat C

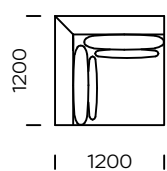
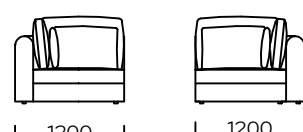

Left seat A1

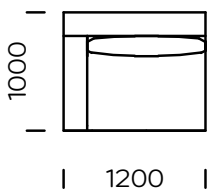
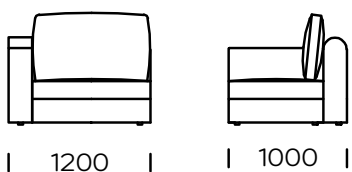

Left seat A2

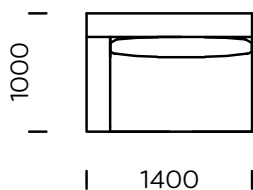
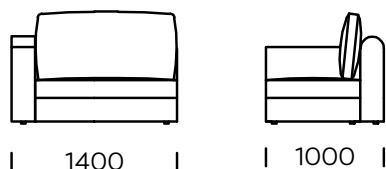

Left seat B1

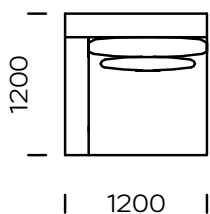
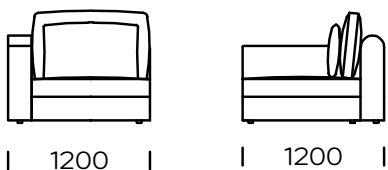

Left seat B2

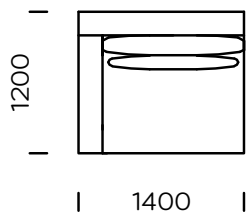
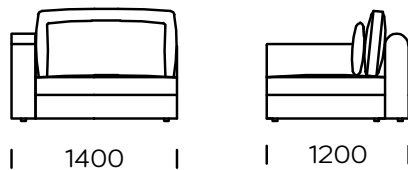

All offered elements can be order in the left and right option

Left chaise longue 1

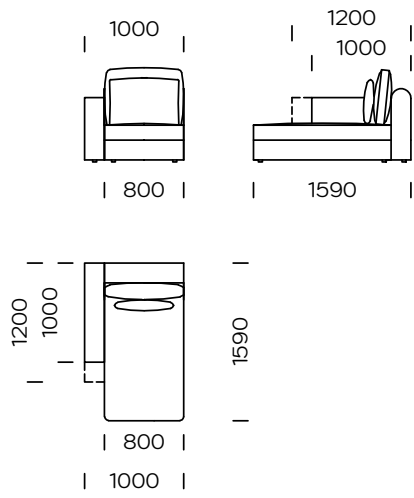

Left chaise longue 2

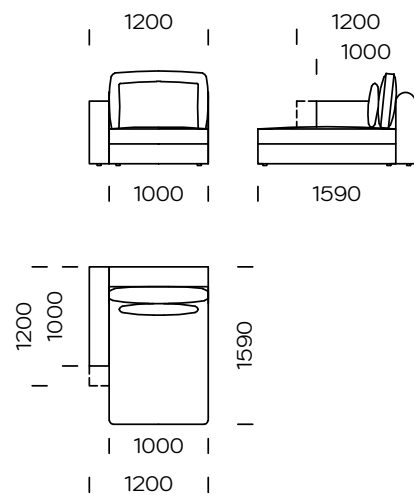

The chaise longue 1 / 2 is equipped with armrest A or B

Left couch A1

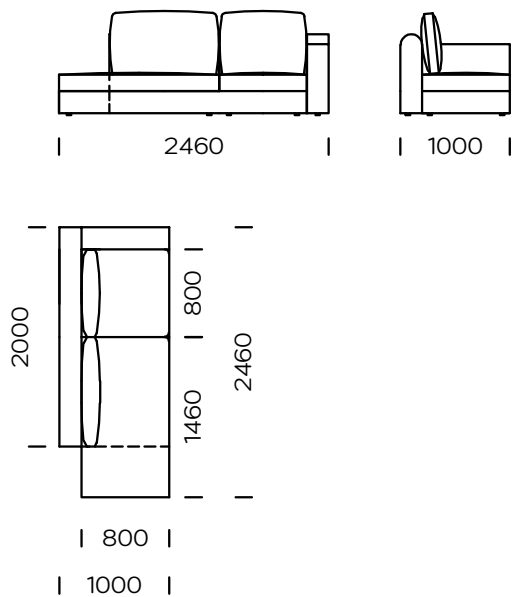

Left couch A2

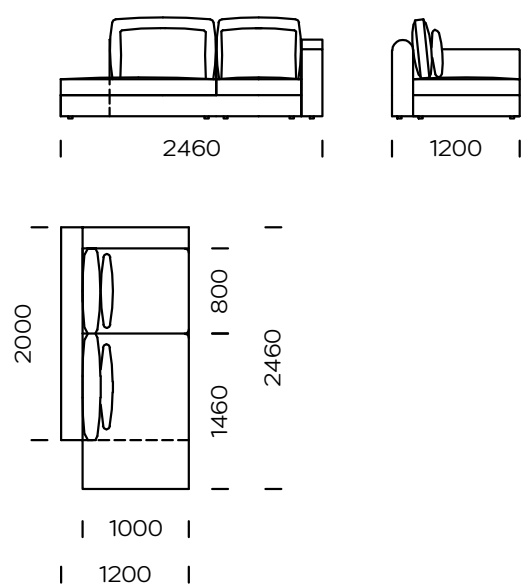

All offered elements can be order in the left and right option

Left couch B1

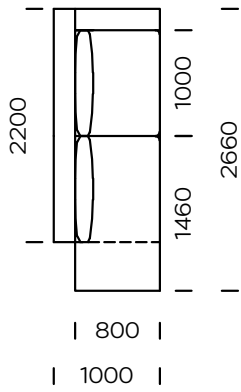
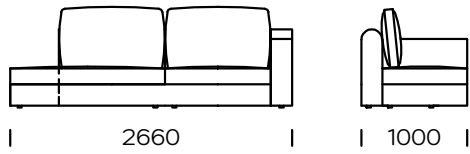

Left couch B2

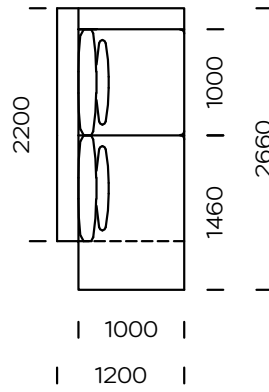
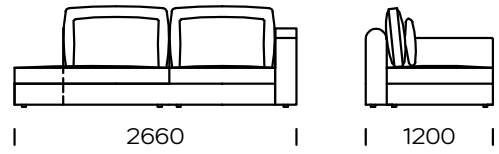

Pouf 1

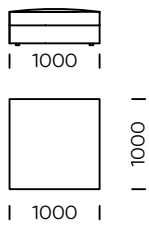

Pouf 2

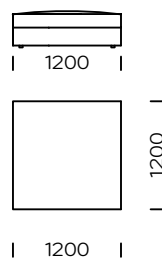

Cushion

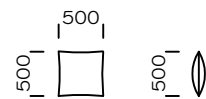

All offered elements can be order in the left and right option